

Forklift Jibs - 'FMJ' Range



The Fork Mounted Jib (FMJ) is a fixed length jib which mounts onto the forks of the fork truck. The ideal attachment for lifting and conveying loads which are not suitable for, or do not require palletising.

Supplied with hook and shackle which can be moved to any of the four suitable lifting positions

Capacity (kg) at Load Centre (mm)

Model Ref	Minimum Truck Capacity (kg)	1000	1250	1500	1750
FMJ 500-0.8	1000	500	380	310	230
FMJ 500-1.0	1300	630	470	388	280
FMJ 500-1.3	1500	680	500	450	380
FMJ 500-1.8	2000	1100	900	720	580
FMJ 500-2.2	2500	1400	1100	1000	830
FMJ 500-2.7	3000	1450	1200	1100	900
FMJ 500-3.1	3500	1900	1500	1200	1000
FMJ 500-3.5	4000	2000	1600	1300	1100
FMJ 500-4.4	5000	2700	2200	1850	1400

Features & Benefits

- Raised hook position for improved visibility whilst keeping hook off the ground when left standing
- Jib rated to suit the capacity of the lift truck, which helps to reduce wear & tear and possible overloading
- Multiple hook positions for flexible load handling whilst reducing handling costs
- Long jib arm helps reach otherwise inaccessible places
- Heel retaining pins ensures jib is safely secured to the forklift forks
- CE marked and supplied with certificate of conformity for health & safety regulations

Forklift Jibs - 'FMJ' Range

Jib Dimensions

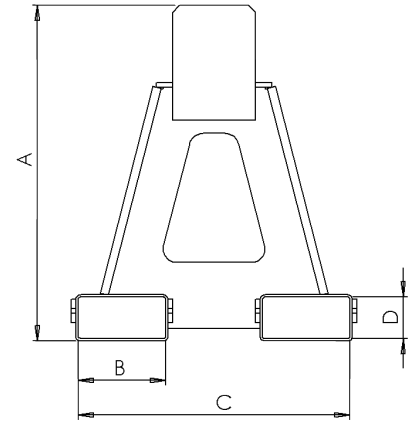
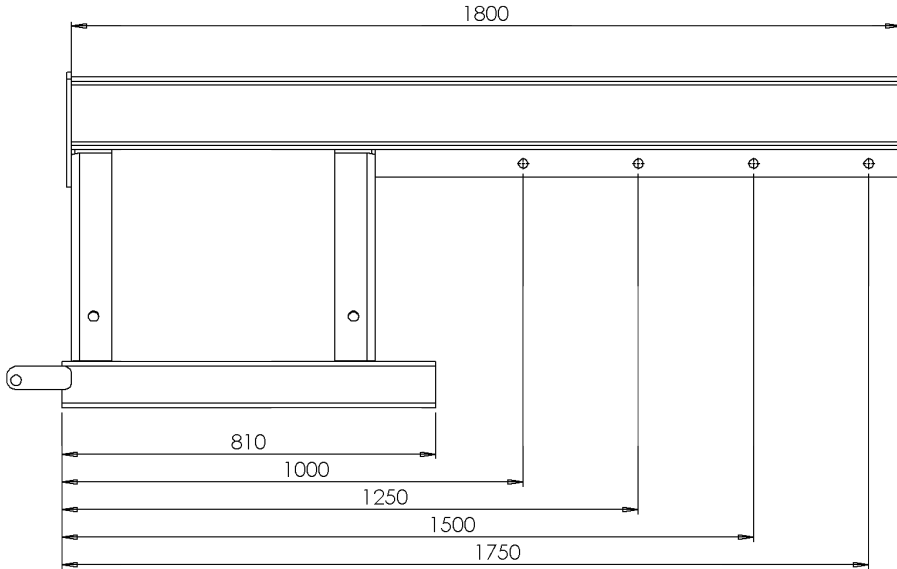

Model Ref	"A" (mm)	"B" (mm)	"C" (mm)	"D" (mm)	Weight (kg)
FMJ 500-0.8	730	150	510	70	108
FMJ 500-1.0	730	150	510	70	108
FMJ 500-1.3	730	150	510	70	108
FMJ 500-1.8	730	150	510	70	108
FMJ 500-2.2	728	180	590	80	136
FMJ 500-2.7	728	180	590	80	136
FMJ 500-3.1	728	180	590	80	136
FMJ 500-3.5	728	180	590	80	136
FMJ 500-4.4	728	180	590	80	136

N.B: Bowl of hook hangs 70mm above the fork blade